

Ruko[®]

3+
for age

User Manual

v2.0

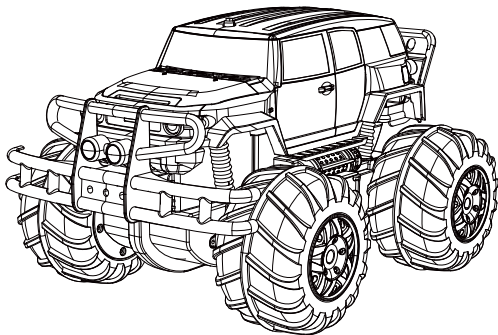

1601AMP2

CONTACT US FOR MORE TECH SUPPORT

 +1 (888)892-0155 | Mon-Fri 7:00AM - 7:00PM (PST)



rukotoy.com

CONTACT US FOR MORE TECH SUPPORT

 +1 (888)892-0155 | Mon-Fri 7:00AM - 7:00PM (PST)

 +86 19129317359

 rukodrone@gmail.com



Contents

1 Reading Tips	2
1.1 Symbolic Interpretation	2
1.2 Read Before Play	2
1.3 Disclaimer and Safety Guidelines	2
1.4 Package Contents	8
2 Transmitter Guidelines	9
2.1 Transmitter Function Buttons	9
2.2 Transmitter Battery Installation	9
3 RC Amphibious Car Guidelines	10
3.1 RC Amphibious Car Parts	10
3.2 RC Amphibious Car Battery Installation	11
3.3 Battery Charging and Maintenance	12
4 Operation Guidelines	14
4.1 RC Amphibious Car Pair Frequency	14
4.2 Land Mode	14
4.3 Surface Mode	16
5 Appendix	18
5.1 Accessories Support	18
5.2 Common Issues & Solutions	19

1 Reading Tips

1.1 Symbolic Interpretation

 Prohibition

 Attention

 Operation Tips

1.2 Read Before Play

Ruko 1601AMP provides tutorial videos and guidance documentation for users:

1. User Manual
2. Tutorial Videos

It's recommended to watch all tutorial videos and read the User Manual before using for the first time. Make sure you are familiar enough with each part's function and totally understand the relevant Disclaimer and Safety Guidelines about this product.

If you have any questions in or before operating, please feel free to contact Ruko after-sales support team at any time.

1.3 Disclaimer and Safety Guidelines

1.3.1 Disclaimer Guidelines

1. Users need to have a basic hands-on operation and a common sense of safety and use it with care.
2. Please be familiar enough with each part's function of the product before operating, inappropriate operation will result in product damage, property loss, or minor personal injury.
3. This product is suitable for children 8 years+ old and adults. Please read all instructions and warnings carefully before operating. It requires correct assembly and use the 1601AMP RC Car strictly follow the relevant instructions.
4. Thank you for purchasing Ruko products. The content mentioned in this User Manual is related to your personal safety, legal interest and liability, the final interpretation right is reserved by Ruko company.
5. Once you use this product, it is deemed that you have carefully read the Disclaimer and Safety Guidelines and accepted the entire contents of the terms. You undertake to take full responsibility for the use of this product and the possible consequences, and undertake to use this product only for legitimate purposes. Meanwhile, you agree to these terms and any relevant regulations, policies and guidelines formulated by Ruko.

1.3.2 Users Guidelines

Preparation before Play :

1. Read the guideline carefully and follow all warnings. Or find someone with operating experience and read it with a guardian if necessary. Improper installation of batteries will be dangerous.
2. When you install or remove the battery cover of the car, you can use tools to remove it, please be careful to avoid scratches.

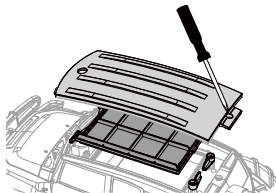

3. Make sure the battery cover screws are properly tightened to prevent the battery from getting wet and falling.
4. The transmitter and vehicle should always use fully charged batteries to avoid losing control of the vehicle.
5. Please use 5V=2A USB to charge the battery before using to ensure sufficient charging time.
6. In terms of battery life, the RC Car has only 60% of the battery before it is sold, so the battery life will be longer after 2-3 charges and discharges.
7. 1601AMP is an amphibious remote-controlled vehicle. Pay attention to safety when playing on the water. Children must be accompanied by adults to avoid drowning.



Cautions and Advice :

1. It is recommended to use this product in an open area without pedestrians to avoid the vehicle hitting people or obstacles.
2. The speed and usage time of water driving and land driving is different.
3. Do not put your fingers or any objects in the rotating and moving parts.
If there is any abnormality during use, please stop using it.
4. The RC Car has a waterproof limit. It is forbidden to press the entire RC Car to the bottom of the water.



Daily Maintenance :

1. Power off the vehicle, then turn off the transmitter, then remove the battery.
2. The car needs routine maintenance after use to clean up foreign objects such as mud and sand.
3. When using the car, the motor will emit heat, and the bottom of the car will heat up, which is normal.
4. It is normal for the battery to heat up after work. Please charge it after cooling down.

1.3.3 Original Accessories:







To avoid possible injury and loss, be sure to observe the following:

1. Use the original accessories, the use of non-original accessories may cause danger to the safe use of the RC Car.
2. Do not disassemble the components installed at the factory by yourself, otherwise, it may affect the performance of the RC Car. and even cause an accident.
3.  The use of non-original charging cables and batteries is prohibited.

1.3.4 Battery Guidelines

To avoid fire, property damage and personal injury, always comply with the following safety guidelines when using, charging and storing batteries.

Important:

1.  Do not immerse the battery in water or get it wet. If the battery accidentally falls into the water, please remove the battery immediately and place it in a safe open area or a special explosion-proof box, away from the battery until the battery is completely dry.  Do not use it again. After the inside of the battery comes into contact with water, a decomposition reaction may occur, causing the battery to spontaneously ignite or even explode.
2. If the battery catches fire, please use solid fire extinguishing equipment such as sand or dry powder fire extinguisher.
3. It is strictly forbidden to use leaked, damaged batteries, and to charge them.  Do not use them when the battery emits odor, heat, deformation, discoloration, or any other abnormal phenomenon.
4. Please use the battery in an environment with a temperature of 10 degrees to 40 degrees. Too high temperature will cause the battery to catch fire or even explode. Too low temperature will seriously damage the battery.
5.  Do not mechanically impact, crush or throw the battery, and do not place heavy objects on the battery or charging device. If the battery is dropped or subjected to external force, it should not be used again.
6. The electrolyte inside the battery is highly corrosive. If it accidentally comes into contact with the skin or eyes, please rinse it with clean water for at least 15 minutes and seek medical attention immediately.
7.  Do not heat the battery or put the battery in a fire.
8.  Do not put the battery in pockets, backpacks, or drawers to prevent a short circuit from contacting with other items. Do not use wires or other metal objects to short circuit the positive and negative electrodes of the battery.
9. If the battery interface is dirty, wipe it with a clean, dry cloth, otherwise, it will cause poor battery contact, resulting in energy loss or charging failure
10. Please remove the battery power cord and cable when not in use. When installing or replacing the battery, please pay attention to the polarity of the battery.

Charging the Battery:

1. Please use the original charger for battery charging, it is recommended to use the original charging cable included in the product package for charging. **⊘** Do not use more than the rated power of the product fast charger, car charger, computer USB port, or USB port on the plug and row.

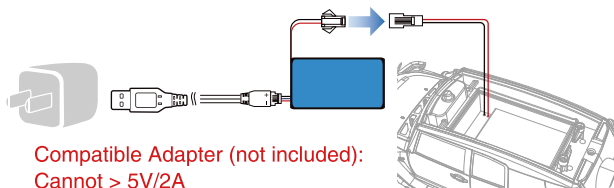

2. **⊘** Do not charge batteries and charging equipment near flammable and combustible objects (such as carpets and wood products). Please always pay attention to the charging process to prevent accidents.
3. **⊘** Prohibit long-term charging, the normal charging time is about 3-4 hours, remember to remove it in time after fully charged.



4. **⊘** It is forbidden to charge the battery as soon as it is used up. The battery is in a high temperature and heating state just after use, or it will cause damage to the battery.
5. After charging, please disconnect the charging device from the battery, check and maintain the charging device regularly, check the appearance of the battery and other parts frequently, do not use alcohol or other flammable to clean the charging device, and **⊘** do not use damaged charging equipment.



6. Please charge the battery under the supervision of adults.
7. Battery recharged by children 8 years of age and older.

Environmental Guidelines:

1. Waste batteries must not be placed with household waste.
2. Batteries are hazardous chemicals and should not be disposed of in ordinary trash cans.
3. Please contact your local environmental or waste management agency, the supplier of your product or the nearest battery recycling center. Please comply with local battery recycling and disposal laws and regulations for relevant details.

Batteries Warnings:





To avoid possible injury and loss, be sure to observe the following:

1. **Keep the battery power at 50%-60% and store it in a cool environment.**
 Avoid high temperature, exposure to the sun, soaking in water, squeezing, and falling from high altitudes.  Do not place the car in a high temperature, humidity and direct sunlight environment.



2. Please store batteries, wires and small parts out of the reach of children and pets to avoid danger.



3. Before taking the battery on the plane, be sure to discharge the battery to below 30%.
4.  Do not transport damaged batteries.
5.  Non-rechargeable batteries cannot be charged.
6.  Different types of batteries or old and new batteries cannot be mixed.
7.  The power terminals cannot be short-circuited.

1.5 Package Contents



RC Amphibious Car



Transmitter



Batteries



Charging cables



Screwdriver



User Manual

2.Transmitter Guidelines

2.1 Transmitter Function Buttons

The transmitter uses the 2.4 GHz frequency band, which can be debugged and played by many people. **The transmitter is up to 40 meters away from the land without obstruction and interference. Unobstructed transmitter distance on water is about 20 meters.**

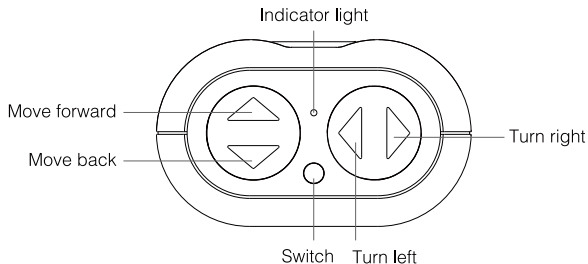

2.2 Transmitter Battery Installation

1. Take a screwdriver and unscrew 2 fixing screws and remove the battery cover.
2. Insert 2 1.5V AAA alkaline batteries.
3. Install the battery cover and tighten the 2 fixing screws.

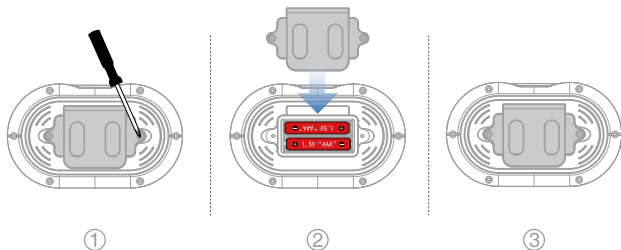

Attention

- ⚠ Please install the transmitter batteries correctly to avoid damage (2 x 1.5V AAA not included).
- Please remove the battery inside the transmitter when it is not used for a long time.
- If the light flashes or goes out during the operation of the transmitter, please check the battery power and replace the battery.
- Please tighten the battery cover fixing screws to achieve the best waterproof effect.

3. RC Amphibious Car Guidelines

3.1 RC Amphibious Car Parts

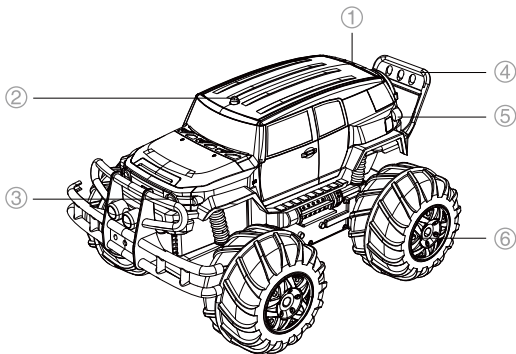

1. Battery compartment screw
2. Switch
3. Head lights

4. Handle
5. Rear head lights
6. Wheels

3.2 RC Amphibious Car Battery Installation

1. Unscrew the upper cover screws and remove the upper cover.
2. Remove the battery compartment fixing clip and remove the battery cover.
3. Connect the body and battery power cable, pay attention to the connect direction of the interface.
4. Reinstall the battery cover and fix the clip.
5. Install the upper cover and tighten the screws.

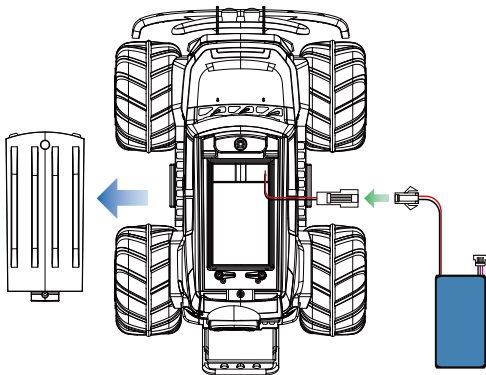

Attention

- ⚠ • When you install or remove the Car's battery cover, you can remove it with a tool, be Careful not to scratch it.
- Make sure the battery cover clips are properly secured to prevent the battery from falling into water.
- Please connect the battery and the body power interface correctly to ensure that they are installed in place.

3.3 Battery Charging and Maintenance

- The RC Car battery has a capacity of 850mAh and a rated voltage of 7.4V.
- Use time on land and water is about: 25 minutes;
- When the speed of the RC Car slows down or stops running, and the headlight flashes rapidly, it is in a low battery state, please continue to play after charging.



1. Please use the **5V/2A USB** charging plug (USB charging plug is self-provided) and the original charging cable for charging.
2. In the charging state, the green indicator light of the charger will flash, the charging is complete, and the green indicator light will be on.
3. **The charging time is about 3 hours. Please remove the charger in time after charging is completed.**

Daily Maintenance

- It is recommended to charge and discharge it once a month. Do not store it with a full charge. Keep 50%-60% of the power. The storage temperature is 10~40°C, and the best storage temperature is 19-21°C.
- The battery enters the water and the battery protection board fails, which will cause the battery to not be used normally. ❌ Do not use the battery in the rain or wet environment, which may cause the battery to spontaneously ignite or even explode.
- If the battery is squeezed and deformed, it is forbidden to use it again.
- ❌ Prohibit long-term high temperature exposure, the battery encounters high temperature will cause the internal pressure of the battery to be too high and cause an explosion.
- If the positive and negative poles are short-circuited for a long time (for example, there is water out of the battery contact, short-circuit caused by foreign objects in hair, etc.), the protection board IC will fail and disconnect, and the battery will not be able to be used normally.
- ❌ It is forbidden to use a fast charger that exceeds the rated power of the battery, please use a 5V/2A USB charger.
- If the RC Car is not used for a long time, the battery must be removed to avoid the battery being in a state of low power discharge for a long time.

4. Operation Guidelines

4.1 RC Amphibious Car Pair Frequency

1. Press down on the body switch to turn on the power of the RC Car.
2. Press the switch down to turn on the remote control.
3. The frequency pairing is performed automatically, and the lights on the body and transmitter will change from flashing to steady light, indicating that the frequency pairing is completed.

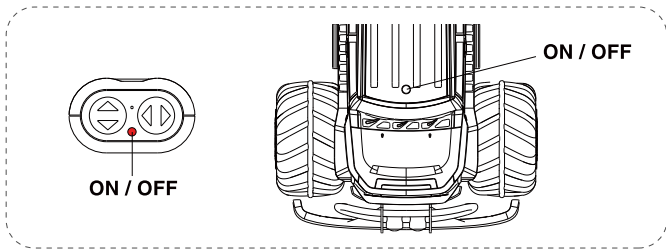

4.2 Land Mode

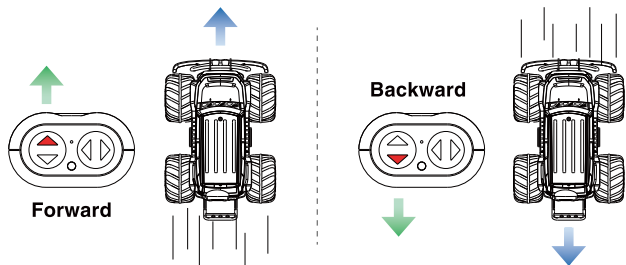

1. Forward: Long press the upper arrow on the left button.
2. Backward: Long press the lower arrow on the left button.

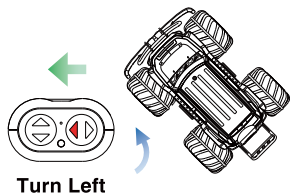

Turn Left

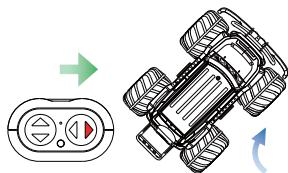

Turn Right

3. Turn left: Press the left arrow on the right button.
4. Turn right: Press the right arrow on the right button.

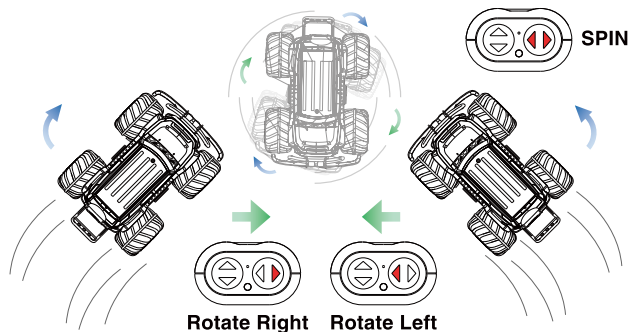

5. Rotate left : Press the left arrow on the right button and hold.
6. Rotate right : Press the right arrow on the right button and hold.

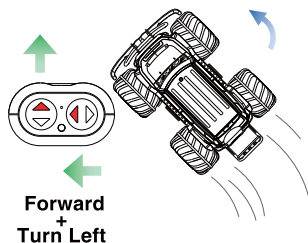

**Forward
+
Turn Left**

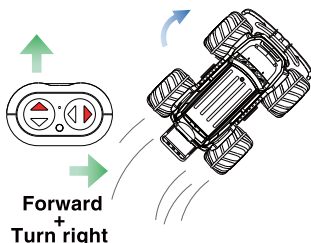

**Forward
+
Turn right**

7. Forward + turn left: long press the above arrow on the left button + press the left arrow on the right button.
8. Forward + turn right: long press the above arrow on the left button + press the right arrow on the right button.
9. Back + turn left: long press the below arrow on the left button + press the left arrow on the right button.
10. Back + turn right: long press the below arrow on the left button + press the right arrow on the right button.

Warning

- ⚠ • During walking, the steering range and sensitivity depend on how hard and how long you turn the steering stick.
- Please practice more to grasp the steering amplitude to avoid loss of control during driving.
- When the lights of the RC Car flash rapidly during operation, the battery is low, please replace the battery.

4.3 Surface Mode

1. Transmitter stick control: the transmitter stick direction control operation method is the same as the land operation method.
2. Performance changes: amphibious vehicle will be slower (land mode 10km/h, surface mode 1.5km/h) and less sensitive to the steering when driving on water due to surface resistance.
3. The battery life and transmitter distance will be shortened. (20 minutes on land, 22 minutes on water)



4. After driving in the sea, on the beach or in the mud, please remove the batteries, wash and dry it, and avoid being corroded or rusted. Then put in a cool and dry place.

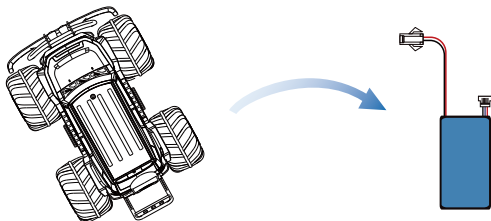

5. Check it the next day after washing, and try to play if it can move normally, to avoid not being rinsed, and to avoid stuck.

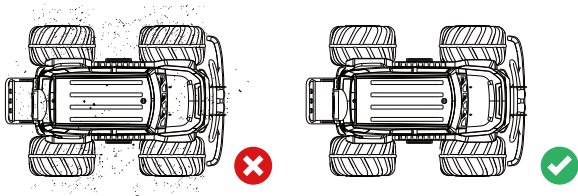

Notice

- ⚠ • Pay attention to personal safety when driving on water, children need to be accompanied by adults to play.
- Please check whether the waterproof structure of the battery cover is normal to prevent water from entering.
- There will be differences in performance between land mode and water mode.

5 Appendix

5.1 Accessories Support



Remote control

Batteries&Charging cable

All of the above accessories can be searched and purchased on Amazon, or you can visit the Ruko store to buy them. Please be sure to use original parts. The use of non-original accessories may endanger the safe use of the RC amphibious Car.

 **WARNING:**
CHOKING HAZARD -Small parts.
Not for children under 3 years.

 **DO NOT OVERLOAD THE CHARGING HEADPHONE DUE TO SMALL PARTS**
خطار: زيارتي اكونا كثر من 3 سنين
مخاطر: زيارتي اكونا كثر من 3 سنين
تحذير: زيارتي اكونا كثر من 3 سنين
خطار: زيارتي اكونا كثر من 3 سنين
COMPANY OF HONGKONG-CHINA
بالمستشار العيني

تمتثلت وفقا للمواصفات والمعايير العالمية
Tested according to international standards



5.2 Common Issues & Solutions

Category	Common Problems	Solutions
Car problems	The Car doesn't respond.	The battery power is low, and the lights flash quickly to indicate low power, please replace it or try it after charging.
	The battery compartment clips cannot be fixed firmly.	Check if the retaining clip screws are loose, and tighten the retaining clip screws.
Battery problems	Can't walk after the battery is plugged into the car.	The battery is dead.
	Short battery life.	<ol style="list-style-type: none"> 1. The ambient temperature is low, which will accelerate battery consumption in cold or snowy days. 2. The battery is not fully charged. 3. Due to the large resistance in the water, the battery life will be shorter than that on land.
	Battery won't charge.	The charging cable or battery is damaged due to the use of a high-power charger.
Use the USB charging head correctly: output: 5V==2A (or below 5V==2A).		
Charging cable problems	The charging cable does not work.	The charging cable or battery is damaged due to the use of a high-power charger.
		Use the USB charging head correctly: output: 5V==2A (or below 5V==2A).
	The battery charging time is more than 3-4hrs.	Please check if you use the appropriate charger, we suggest to use the charger with an output current of 5V / 2A.
Operational Problems	Lost control when turning around.	The magnitude of the steering depends on how long you control the steering remote control stick, adjusting the strength and time according to the magnitude of the steering you want to achieve to achieve your expectations.

Category	Common Problems	Solutions
Transmitter problems	The transmitter does not power on.	The transmitter battery needs to use 2 1.5V AAA non-rechargeable batteries, the positive and negative poles of the battery should not be reversed.
	The transmitter is out of frequency.	If the transmitter is damaged due to accidents such as falling, water, etc., you can purchase a new remote control from the purchase channel or manufacturer.
Maintainance	How to maintain after playing in the water.	Remove the battery after playing in the water, please dry the car.
	Water leaking into the battery compartment.	The cover isn't fastened, please ensure to lock the four cover tabs.

Ruko Tech Support
<https://rukotoy.com/support-rccars>

This User Manual is subject to change without notice.

**You can check the recently updated version of "User Manual"
on Ruko's official website**
<https://rukotoy.com/support-rccars>

If you have any questions or suggestions about the User Manual,
please contact us via the following email:
Rukofunnytoys@gmail.com

Ruko is a trademark of Shenzhen Ruike Innovation Technology Co.,Ltd
Copyright 2022 Ruko All Rights Reserved.

Ruko[®]

rukotoy.com

CONTACT US FOR MORE TECH SUPPORT

 +1 (888)892-0155 | Mon-Fri 7:00AM - 7:00PM (PST)

 +86 19129317359

 rukodrone@gmail.com

